



MSR206

**Magnetic Stripe Card Reader/Writer
(High & Low Coercivity)**

Programmer's Manual

Document PM017-U

Revision C.1

09 Oct. 2003'

Table of Contents

Section 1	Introduction	1
	Accessories of MSR206	1
	Warranty	1
Section 2	General description	2
Section 3	Technical specifications	3
Section 4	Setup	5
Section 5	Utilities test program	6
	System requirement	6
	Test program installation	6
Section 6	Command and response	10
Section 7	Data format	14
Section 8	Communication sequence	16
	8.1 MSR 206 INITIALIZATION	16
	8.2 WRITE DATA TO MSR 206	16
	8.3 READ DATA TO MSR206	16
Section 9	Addendum	18
	(I) WRITE DATA TO MAGNETIC CARD	18
	(II) WRITE RAW DATA TO MAGNECTIC CARD	19

Section 1 Introduction

Thank you for purchasing the MSR 206 Manual Swipe Magnetic Card Reader/Writer. It is ideal for access control, time keeping, banking, ID recognition & credit verification and related applications. In fact, wherever a magnetic stripe ID or transaction card is used, one can find a related use for the versatile, user-friendly MSR206 reader/writer.

The MSR 206 is designed to offer a reading and writing solution of high and/or low coercivity cards that will attractively complement an existing system.

This manual provides detailed information about the MSR 206. For ease of installation and programming use, we have addressed everything from its attractive features to its various configurations.

When designing the MSR 206, we selected what we feel are the most useful features and functions. If in some cases you find that your specific needs differ from our existing products, we welcome your comments and suggestions.

Custom-designed models are also available.

This MSR206 series has been tested and found to comply with the limits for a Class A digital device, pursuant to part 15 of the FCC Rules. These limits are designed to provide reasonable protection against harmful interference when the equipment is operated in a commercial environment.

This equipment generates, uses, and can radiate radio frequency energy and, if not installed and used in accordance with the instruction manual, may cause harmful interference to radio communications. Operation of this equipment in a residential area is likely to cause harmful interference in which case the user will be required to correct the interference at his own expense.

This MSR206 series also had been tested and found to comply with the agency requirements of specification for CE mark Class B

EN 50 082-1: 1992	EN 55 022: 1994 Class B
IEC 801-2: 1984	EN 61000-3-2: 1995 Class A
IEC 801-3: 1984	EN 61000-3-3: 1995
IEC 801-4: 1988	

➤ Accessories of MSR206

Make sure all the following accessories are contained in your package:

1. Switch power Supply, AC 110~240V in / DC 24V, 2.2A out.
2. Power cord.
3. Signal cable (DB9 to RJ45, 1.5m)
4. Utility disk (A/P S/W).
5. Blank Hi-Co test card.(or and Low-Co test card)
6. Programmer's manual

➤ Warranty

One year after purchase of MSR206, any alteration and/or erasure or modification of the MSR206 will void the warranty.

Section 2 General description

The MSR206 series is designed to read and/or write high or low coercivity magnetic cards. It can encode and verify up to 3 tracks of data simultaneously. It communicates with a host computer or other terminal using a standard RS-232 interface.

Section 3 Technical specifications

ITEM	SPECIFICATION
Standard	ISO7811
Electrical	
Consumption	Current/operating Typical 350mA Max
	600mA plus for each writing track
Communication	Standard RS232 signal voltage levels. Default, 9600 Baud, None Parity, 8 bits
Power supply	External switching Power 24V/2.2A regulated
Interconnection	
Cable	RJ45->DB9, 5 feet
Pin Assignment DB-9	1. shield
	2. TXD / MSR206 data transmit
	3. RXD / MSR206 data receive
	4,6,7,8,9, no connection
	5. circuit ground
Mechanical	
Body	ABS 94V-0
Swipe	Manual, single direction
Outline	210Lx68Wx60H mm
Weight	1.5Kg approx.
Environment	
Operation	-10°C to 60°C
	10 to 85% humidity, non condensing
Storage	-30°C to 70°C
	10 to 90% humidity, non condensing

Performance	
Read Circuit	Track 1&3 210bpi
	Track 2,75 or 210 bpi
Bit per Char	5-7 bit per char.
Media Speed	Read, 5-50 ips (read speed 5-40 ips for track 2 at 210bpi)
	Write, 5-30
Media Coercivity	Read 300-4000 Oe Mag. Card
	MSR206-XHC write 2750-4000 Oe Mag. Card
	MSR206-XHL write 300-4000 Oe Mag. Card
Media Thickness	0.76-1.2mm
Jitter Card	Read bit to bit interval <+/-15% card

	Write bit to bit interval <+/-10%,Sub interval<+/-12% at 30ips			
Low amplitude Card	Read 60% for both 75& 210bpi			
Error Rate	Read < 0.5%			
	Write < 0.8%			
Media Swipe	Head life 1,000,000 passes for both read & write head			
Configuration Available Model	Model	Read/Write Track	Hi-C	Lo-C
	MSR206-3HC	1,2&3	R/W	R
	MSR206-5HC	1&2	R/W	R
	MSR206-1HL	2	R/W	R/W
	MSR206-3HL	1,2&3	R/W	R/W
	MSR206-5HL	1&2	R/W	R/W

Section 4 Setup

1. Power off your system (PC).
2. Connect PC and MSR206 as below.

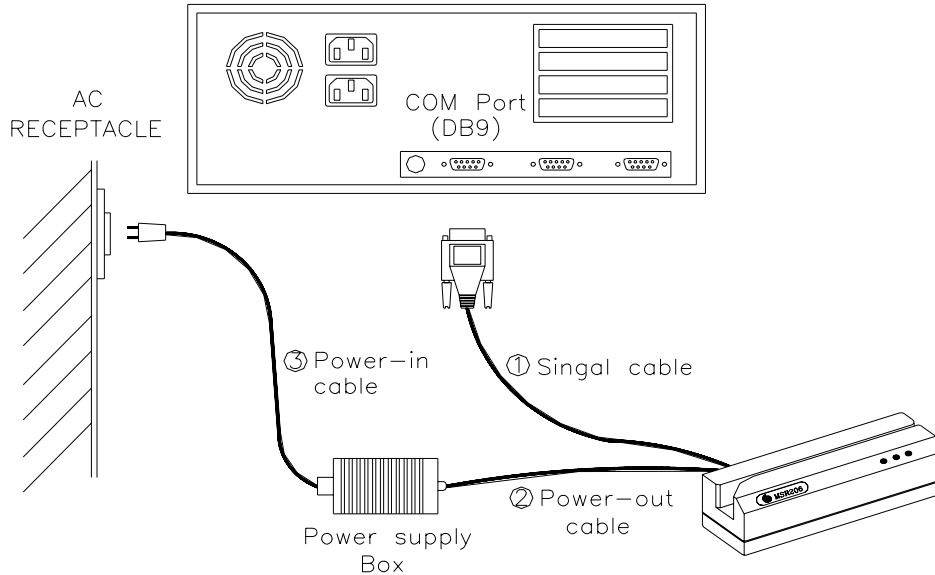

3. Connect DB9 of ① signal cable to a free serial port then connect RJ45 at the other end of the cable to MSR206
4. Connect outer plug of ② Power-out cable to the power inlet of MSR206.
5. Connect ③ Power-in cable to Power supply and AC receptacle (110V~240V).
6. Power on your system (PC).

Section 5 Utilities test program

Every MSR206 comes with a utilities test program disk that includes a **Windows** version. This program is to verify and demonstrate the functionality of the MSR206. In some cases, it can be used as a card reading and writing program.

➤ System requirement

- a. 80286 PC/AT compatibles or later model with color display.
- b. Either the following operating systems: Windows 95, Windows 98, Windows 2000, or NT4.0.
- c. 256K available conventional memory.
- d. A free serial port (Com 1 or Com 2) with DB9 male connector.

➤ Test program installation

User shall follow the steps below in order to install test program

- A. Connect MSR206 to RS232 port, and power on it.
- B. Insert utility diskette into floppy disk drive on PC, and execute the self-extracting file (e.g.: MSR206.exe)
- C. Execute test program from the subdirectory of 'Demo AP' (e.g. 206DDX21.exe)

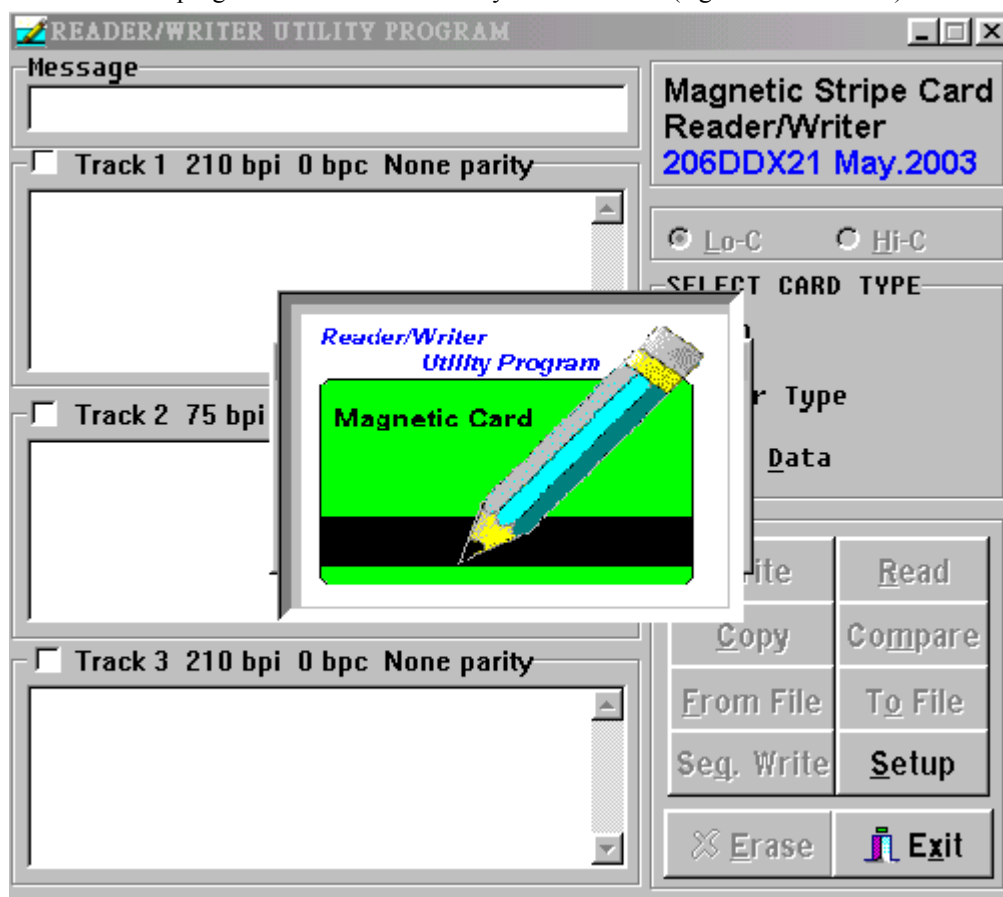

- D. The test program will auto-detect communication port. If there is any errors occurred, it'll appear in the information dialog box after opening the program. User can close the AP by pressing OK button.



E. If “**Not Find Reader/Writer!**” appears in the information dialog box after opening the program, check to see that the DB9 connector is plugged into the correct COM port and the power cord/connector is also attached to DB9 thus lighting the green LED on the MSR206.

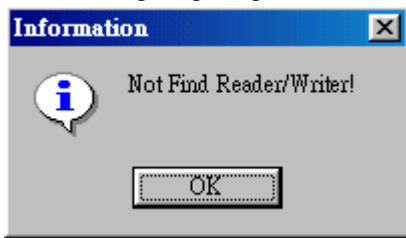

F. When the test program is first opened, a password dialog box will ask whether you wish a first time password. If yes, enter a password of one or more characters, maximum to 16 characters. And proceed to step H.



G. If a password is not required, press ESC and a dialog box will ask you to confirm that a password is not required. Click on Yes and proceed to demo program.

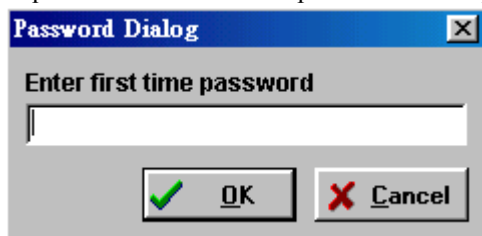

H. When entering a password for the first time, the system will require you to confirm the password, Click OK, after you reenter your password.

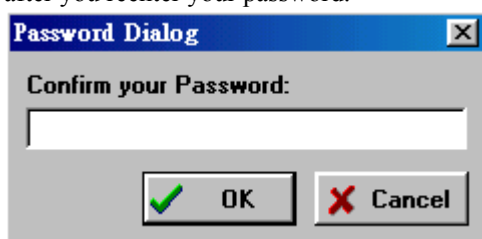

* Remember the password you entered, because if it is forgotten, you must re-install the Test Program.

* Remember, however; should you desire password protection in the future, you must re-install the program.

I. When the test program is opened, you'll see the main window of the READER/WRITER UTILITY PROGRAM.

From this main window you can activate all functions by clicking the appropriate buttons and following the on screen instructions.

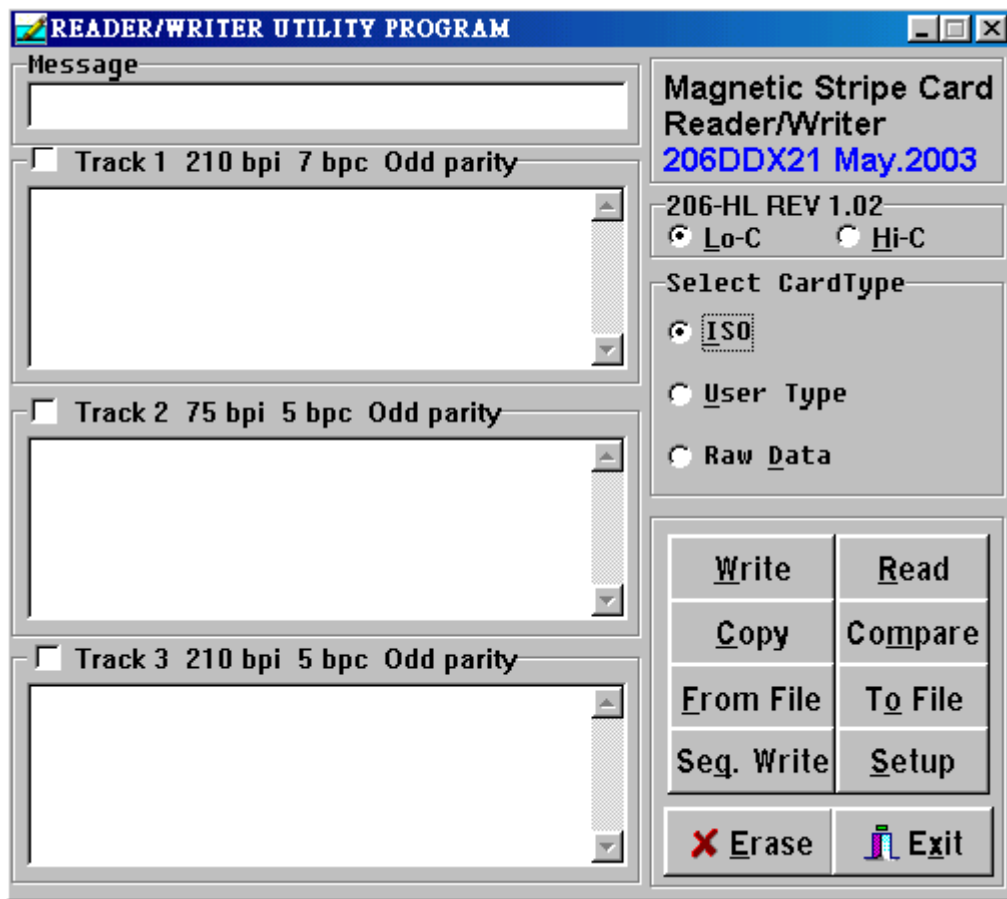

J. The test program will auto detect if a MSR206 is connected.

By clicking Setup from main window, you can change COM ports, Leading Zeros for all 3 tracks and BPI of track 2.

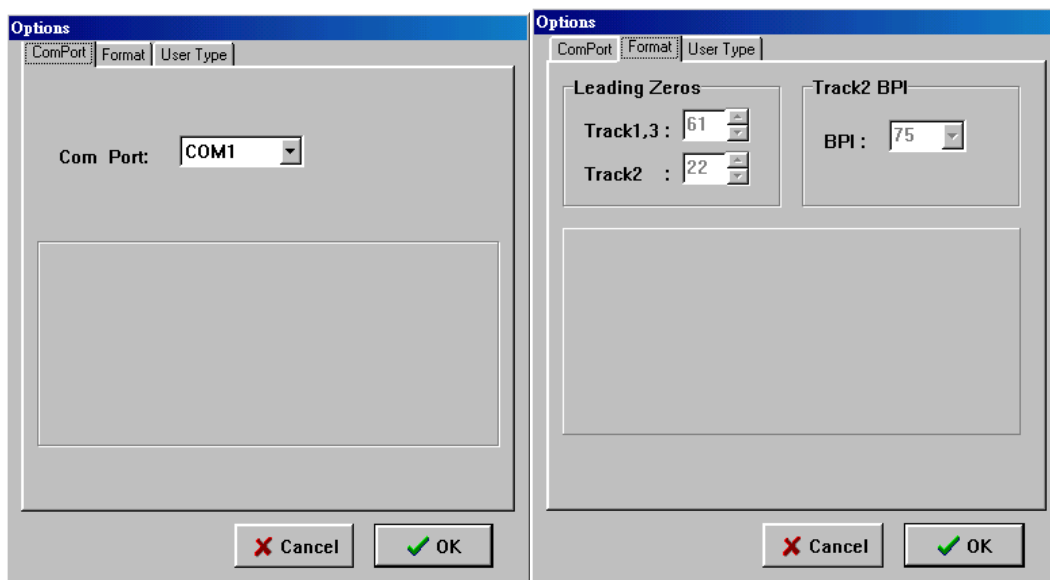

K. By choosing User Type from the main window, you can then define your user parameters by clicking Setup & selecting User Type.

Options

ComPort | Format | **User Type**

Track 1

BPC : 7 Parity : Odd

SS : % ES : ?

Track 2

BPC : 5 Parity : Odd

SS : ; ES : ?

Track 3

BPC : 5 Parity : Odd

SS : ; ES : ?

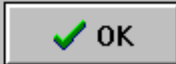
 Cancel  OK

Section 6 Command and response

This section gives detailed description of commands to the MSR206 and the corresponding response from MSR206.

Notional Conventions:

<ESC>	Control character named
[[[[[sname]	Special string named sname, meaning can be found in section 7. ie.[Data Block] [Status Byte] [Select Byte] etc.
X	Standard ANSI character

Command Description:

1. Command: **RESET**

Command code: <ESC> a

Hex code: 1B 61

Response: none

Description: This command reset the MSR206 to initial state.

2. Command: **READ**

Command code: <ESC> r

Hex code: 1B 72

Response: [Data Block] <ESC> [Status Byte]

Description: This command request MSR206 to read a card swiped and respond with the data read.

3. Command: **WRITE**

Command code: <ESC> w [Data Block]

Hex code: 1B 77 [Data Block]

Response: <ESC> [Status Byte]

Description: This command request MSR206 to write the Data Block into the card swiped.

4. Command: Communication test

Command code: <ESC> e

Hex code: 1B 65

Response: <ESC> y [1B] [79])

Description: This command is used to verify that the communication link between computer and MSR206 is up and good.

5. Command: **All LED off**

Command code: <ESC> <81>

Hex code: 1B 81

Response: none

Description: This command is used to turn off all the LEDs.

6. Command: **All LED on**

Command code: <ESC> <82>

Hex code: 1B 82

Response: none

Description: This command is used to turn on all the LEDs.

7. Command: GREEN LED on

Command code: <ESC> <83>

Hex code: 1B 83

Response: none

Description: This command is used to turn on Green LED.

8. Command: YELLOW LED on

Command code: <ESC> <84>

Hex code: 1B 84

Response: none

Description: This command is used to turn on the Yellow LED.

9. Command: **RED LED on**

Command code: <ESC> <85>

Hex code: 1B 85

Response: none

Description: This command is used to turn on the Red LED.

10. Command: **Sensor test**

Command code: <ESC> <86>

Hex code: 1B 86

Response: <ESC> 0 (1B 30) if test ok

Description: This command is used to verify that the card sensing circuit of MSR206 is working properly
MSR206 will not response until a card is sensed or receive a RESET command.

11. Command: **Ram test**

Command code: <ESC> <87>

Hex code: 1B 87

Response: <ESC> 0 (1B 30) ram test ok; <ESC> A (1B 41) ram test fail

Description: This command is used to request MSR206 to perform a test on its on board RAM.

12. Command: Set leading zero

Command code: <ESC> z [leading zero of track 1 & 3] [leading zero of track 2]

Hex code: 1B 7A [00~ff] [00~ff]

Response: <ESC> 0 (1B 30) set ok

<ESC> A (1B 41) set fail

Description: This command is used to set how many leading zeros will be written before the card data starts, and
the space should calculated as [leading zero] X25.4 / BPI (75or210) =mm

Default setting of leading zero: [3D] [16]

TK1 & TK3: [3D] means leading zero=61

TK2: [16] means leading zero=22

13. Command: Check leading zero

Command code: <ESC> 1

Hex code: 1B 6C

Response: 1B [00~ff] [00~ff]

Description: This command is used to ask MSR206 the present setting number of leading zeros.

14. Command: Erase card

Command code: <ESC> c [Select Byte]

Hex code: 1B 63 [Select Byte]

Response: <ESC> 0 [1B] [30] command Select Byte ok

<ESC> A [1B] [41] command Select Byte fail

Description: This command is used to erase the card data when card swipe.

*[Select Byte] format:

00000000: Track 1 only

00000010: Track 2 only

00000100: Track 3 only

00000011: Track 1 & 2

00000101: Track 1 & 3

00000110: Track 2 & 3

00000111: Track 1, 2 & 3

15. Command: **Select BPI** (only for TK2)

Command code: <ESC> b [Density]

Hex code: 1B 62 [D2 or 4B]

Response: <ESC> 0 [1B] [30] select ok

<ESC> A [1B] [41] select fail

Description: This command is used to select the density of TK2.

[D2]: TK2 BPI=210 [4B]: TK2 BPI=75

16. Command: Read raw data

Command code: <ESC> m

Hex code: 1B 6D

Response: [Raw Data Block] <ESC> [Status Byte]

Description: This command requests MSR206 to read a card swipe but send without ASCII decode.

Refer to [Raw Data Block] & [Raw Data] format.

17. Command: Write raw data

Command code: <ESC> n [Raw Data Block]

Hex code: 1B 6E [Raw Data Block]

Response: <ESC> [Status Byte]

Description: This command requests MSR206 to write raw Data Block into the card swiped.

Refer to [Raw Data Block] & [Raw Data] format.

18. Command: Get device model

Command code: <ESC> t

Hex code: 1B 74

Response: <ESC> [Model] S

Description: This command is used to get the model of MSR206. There are four models

Model 1, 2, 3, & 5

Models	Description
MSR206-1	Track 2
MSR206-2	Track 2 & 3
MSR206-3	Track 1,2 & 3
MSR206-5	Track 1 & 2

19. Command: Get firmware version

Command code: <ESC> v

Hex code: <ESC> 76

Response: <ESC> [version]

Description: This command can get the firmware version of MSR206.

* [version] is a 5 bytes version number, format is “ REV?X.XX “

MSR206? = 0

MSR206HC? = H

MSR206HL? = U

20. Command: **Set BPC**

Command code: <ESC> o [tk1bit][tk2bit][tk3bit]

Hex code: <ESC> 6F [05-08][05-08][05-08]

Response: <ESC> 30 [tk1bit][tk2bit][tk3bit]

Description: This command is used to set the bit per character of every track.

21. Command: **Set Hi-Co**

Command code: <ESC> x

Hex code: 1B 78

Response: <ESC> 0

Description: This command is used to set MSR206HL status to write Hi-Co card.

22. Command: **Set Low-Co**

Command code: <ESC> y

Hex code: 1B 79

Response: <ESC> 0

Description: This command is used to set MSR206HL status to write Low-Co card.

23. Command: Get Hi-Co or Low-Co status

Command code: <ESC> d

Hex code: 1B 64

Response: <ESC> H -----to write Hi-Co

: <ESC> L ----- to write Low-Co

Description: This command is to get MSR206HL write status

Section 7 Data format

* [Data Block] format:

	Start Field	R/W Data Field	Ending Field
Command code	<ESC> s	[Card data]	? <FS> <ESC> [Status]
Hex code	1B 73	[Card data]	3F 1C 1B [Status]

* [Card data] format:

	Card Data
Char Code	<ESC> 1[string1] <ESC> 2 [string2] <ESC> 3 [string3]
Hex Code	1B 01 [string1] 1B 02 [string2] 1B 03 [string3]

* [Status Byte] format:

Status	description	HEX	ASCII
Ok	If read, write or command ok	30h	0
Error	Write or read error	31h	1
	Command format error	32h	2
	Invalid command	34h	4
	Invalid card swipe when in write mode	39h	9

* Note:

1. When [Status Byte] equal 39h means card moving error
2. None available and none data tracks will not be transmitted when swipe of card.

For example, when read card with data encoded on track 2 only for MSR206-5, it will transmit data like **1B 73 1B 01 1B 02 [string] 3F 1C**, for no data on track 1 so it shown 1B 01 only.

* [Raw Data Block] format:

	Start Field	R/W Data Field	Ending Field
Command code	<ESC> s	[Raw data]	? <FS> <ESC> [Status]
Hex code	1B 73	[Raw data]	3F 1C 1B [Status]

* [Raw Data] format:

	Raw Data
Char Code	<ESC>1[L1][string1]<ESC>2[L2][string2]<ESC>3[L3][string3]
Hex Code	1B 01[L1][string1]1B 02[L2][string2]1B 03[L3][string3]

Note:

1. [L1], [L2], [L3] is the length of [string1],[string2],and [string3]
2. None available and none data tracks will not output when swipe of card,

For example, when read card (encoded data on track 2 only) on MSR206-5, it will transmit data like

1B 73 1B 01 00 1B 02 [L2] [string] 3F 1C

* [Raw Data] bit orientation:

Track 1 for 8 BPC

Read

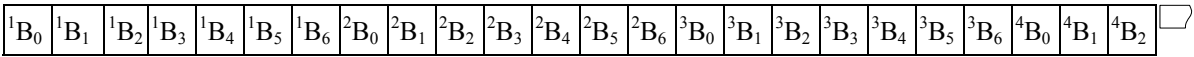

Write

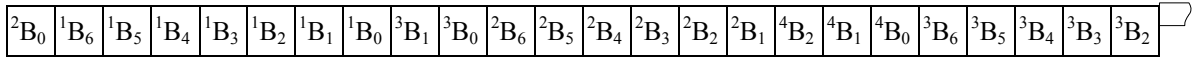

Track 2 & 3 for 8 BPC

Read

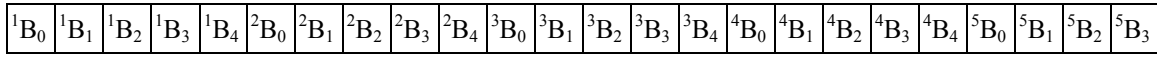

Write

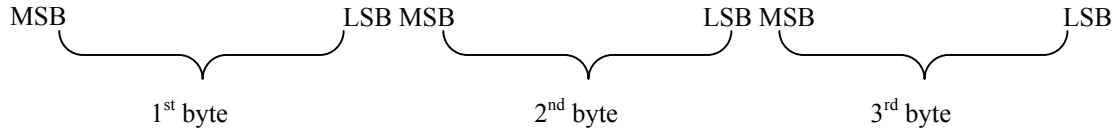
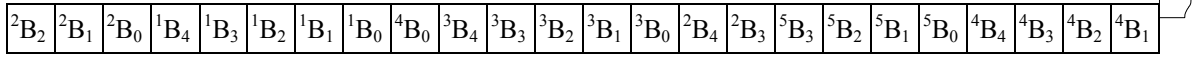

*Refer to 9.ADDENDUM

Section 8 Communication sequence

The examples below assumes data on track1, 2 & 3 to be 01, 23, 45 respectively

➤ 8.1 MSR 206 INITIALIZATION

HOST	Direction	MSR206
Command code: <ESC>a HEX code: [1B][61]	→	(Reset)
Command code: <ESC>e HEX code: [1B][65]	→ (Serial port test)	
	←	Command test ACK: <ESC>y HEX code: [1B][79]
Command code: <ESC>a HEX code: [1B][61]	→	(Reset)

➤ 8.2 WRITE DATA TO MSR 206

HOST	Direction	MSR206
Command code: <ESC>w<ESC>s<ESC>[01]01 <ESC>[02]23<ESC>[03]45?<FS> HEX code: [1B][77][1B][73][1B][01][30][31][1B] [02][32][33][1B][03][34][35][3F][1C]	→ (write command)	
	← (status ACK)	(Wait until swipe card) Command ACK: <ESC> <status> HEX code: [1B][status] Status =[30] no error Status =[31]~[3F] if error

➤ 8.3 READ DATA TO MSR206

HOST	Direction	MSR206
Command code: <ESC>r HEX code: [1B][72]	→ (read command)	

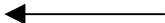
	<p>(status ACK)</p> 	<p>(Wait until swipe card)</p> <p>Command ACK:</p> <p><ESC>s<ESC>[01]%01?<ESC>[02];23?<ESC>[03];45??<ESC> FS><ESC><status></p> <p>HEX code:</p> <p>[1B][73][1B][01][25][30][31][3F][1B][02][3B][32][33][3F] [1B][03][3B][34][35][3F][3F][1C][1B][status]</p> <p>Status=[30] ok Status=[31]~[3F] if error</p>
--	-------------------------------------------------------------------------------------------------------	----------------------------------------------------------------------------------------------------------------------------------------------------------------------------------------------------------------------------------------------------------------------------------------------------------------------------------------------------------------------------------------------------------------

* [XX] = HEX Code XX

Section 9 Addendum

➤ (I) WRITE DATA TO MAGNETIC CARD

The WRITE command:

Command	WRITE
Command code	<ESC> w [Data Block]
Hex code	1B 77 [Data Block]
Response	<ESC> [Status Byte]
Description	This command request MSR106 to write the Data Block into the card swiped.

[Data Block] format:

	Start Field	R/W Data Field	Ending Field
Command code	<ESC>s	[card data]	?<FS>
HEX code	1B 73	[card data]	3F 1C

[card data] format:

	card data
Char. code	<ESC>[01] [string] <ESC> [02] [string] <ESC> [03] [string3]
HEX code	1B 01 [string1] 1B 02 [string2] 1B 03 [string3]

As an example the following information will be written to the card:

Track1: %ABC123?

Track2: ;12345?

Track3: ;12345?

HOST	DIRECTION	MSR106/MSR206
Command code: <esc>w<ESC>s<ESC>[01]ABC123<ESC> [02]12345<ESC>[03]12345?<FS> HEX code: [1B][77][1B][73][1B][01][41][42][43][31][32][33][1B][02][31][32][33][34][35][1B][0 3][31][32][33][34][35][3F][1C]	(write command)	
After send command to MSR106/206	Yellow LED on, then swipe card	write data to the magnetic card
	(status ACK)	(wait until swipe card) Command ACK: <ESC><status> HEX code: [1B][status] Status = [30] no error Status = [31] ~ [3F] if error

➤ (II) WRITE RAW DATA TO MAGNETIC CARD

Converting Card Data Information to Hexadecimal for the Binary Write Function

Converting track one ASCII information into HEX

	B3	B2	B1	B5 B0 B4	0	1	2	3
					0	0	1	1
					0	1	0	1
0	0	0	0	0	(sp)	0	@	P
1	0	0	0	1	!	1	A	Q
2	0	0	1	0	“	2	B	R
3	0	0	1	1	#	3	C	S
4	0	1	0	0	\$	4	D	T
5	0	1	0	1	%	5	E	U
6	0	1	1	0	&	6	F	V
7	0	1	1	1	‘	7	G	W
8	1	0	0	0	(8	H	X
9	1	0	0	1)	9	I	Y
A	1	0	1	0	*	:	J	Z
B	1	0	1	1	+	;	K	[
C	1	1	0	0	`	<	L	\
D	1	1	0	1	,	=	M]
E	1	1	1	0	.	>	N	^
F	1	1	1	1	/	?	O	_

Converting track two and three ASCII information into HEX

Data	p	B3	B2	B1	B0
0	1	0	0	0	0
1	0	0	0	0	1
2	0	0	0	1	0
3	1	0	0	1	1
4	0	0	1	0	0
5	1	0	1	0	1
6	1	0	1	1	0
7	0	0	1	1	1
8	0	1	0	0	0
9	1	1	0	0	1
:	1	1	0	1	0

; (*)	0	1	0	1	1
<	1	1	1	0	0
=	0	1	1	0	1
>	0	1	1	1	0
? (*)	1	1	1	1	1

* Note: The “;” is start sentinel and “?” is end sentinel of tk2 & 3 of ISO format.

As an example the following information will be written to the card:

Track1: %ABC123?

Track2: ;12345?

Track3: ;12345?

We use three different data bits to write raw data on the cards. The procedures are listed as below:

08, 08, 08 BITS

Set each track as 08.

First of all, set BPC command:

1B, 6F, 08, 08, 08

Present the information to the card encoder, as follows:

Start Field	1B6E1B73
Track1 header	1B01
Length	08
Track1 data	C5B07814954E3E2A
Track header	1B02
Length	05
Track2 data	2B8849EAAF
Track3 header	1B03
Length	05
Track3 data	2B8849EAAF
Ending Field	3F1C

Transfer the track1 data to HEX under 08 bits:

	B0	B1	B2	B3	B4	B5	P
%	1	0	1	0	0	0	1
A	1	0	0	0	0	1	1
B	0	1	0	0	0	1	1
C	1	1	0	0	0	1	0
1	1	0	0	0	1	0	1
2	0	1	0	0	1	0	1
3	1	1	0	0	1	0	0
?	1	1	1	1	1	0	0

LRC	0	1	0	1	0	1	0
-----	---	---	---	---	---	---	---

Calculate Odd Parity (P column)

If there is an Even Number of 1's in the row of data for each character, put a 1 in the P column. Other wise, put a 0 in the column.

LRC: If there is an Even Number of 1's in the column of data for each character, put a 0 in the LRC row. Other wise, put a 0 in the row. The last LRC will be considered as the parity rule of this row.

B0	B1	B2	B3	B4	B5	B6	B7	
1	0	1	0	0	0	1	1	
0	0	0	0	1	1	0	1	
0	0	0	1	1	1	1	0	
0	0	1	0	1	0	0	0	
1	0	1	0	1	0	0	1	
0	1	1	1	0	0	1	0	
0	1	1	1	1	1	0	0	
0	1	0	1	0	1	0	0	

B7	B6	B5	B4	B3	B2	B1	B0	HEX
1	1	0	0	0	1	0	1	C5
1	0	1	1	0	0	0	0	B0
0	1	1	1	1	0	0	0	78
0	0	0	1	0	1	0	0	14
1	0	0	1	0	1	0	1	95
0	1	0	0	1	1	1	0	4E
0	0	1	1	1	1	1	0	3E
0	0	1	0	1	0	1	0	2A

Transfer track 2 (track 3) data to HEX under 08 bits:

	B0	B1	B2	B3	P
;	1	1	0	1	0
1	1	0	0	0	0
2	0	1	0	0	0
3	1	1	0	0	1
4	0	0	1	0	0
5	1	0	1	0	1
?	1	1	1	1	1
LRC	1	0	1	0	1

B0	B1	B2	B3	B4	B5	B6	B7
1	1	0	1	0	1	0	0

0	0	0	1	0	0	0	1
1	0	0	1	0	0	1	0
0	1	0	1	0	1	1	1
1	1	1	1	0	1	0	1

B7	B6	B5	B4	B3	B2	B1	B0	HEX
0	0	1	0	1	0	1	1	2B
1	0	0	0	1	0	0	0	88
0	1	0	0	1	0	0	1	49
1	1	1	0	1	0	1	0	EA
1	0	1	0	1	1	1	1	AF

07. 05. 05 BITS

Set TK1, TK2 & TK3 as 07, 05, 05

1b, 6F, 07, 05, 05

First of all, set BPI command:

Present the information to the card encoder, as follows:

Start Field	1B6E1B73
Track1 header	1B01
Length	09
Track1 data	456162235152131F2A
Track2 header	1B02
Length	08
Track2 data	0B01021304151F15
Track3 header	1B03
Length	08
Track3 data	0B01021304151F15
Ending Field	3F1C

Transfer the track1 data to HEX under 07 bits:

	B0	B1	B2	B3	B4	B5	P
%	1	0	1	0	0	0	1
A	1	0	0	0	0	1	1
B	0	1	0	0	0	1	1
C	1	1	0	0	0	1	0
1	1	0	0	0	1	0	1
2	0	1	0	0	1	0	1
3	1	1	0	0	1	0	0
?	1	1	1	1	1	0	0
LRC	0	1	0	1	0	1	0

Calculate Odd Parity (P column)

If there is an Even Number of 1's in the row of data for each character, put a 1 in the P column. Other wise, put a 0 in the column.

	Add	P	B5	B4	B3	B2	B1	B0	HEX
%	0	1	0	0	0	1	0	1	45
A	0	1	1	0	0	0	0	1	61
B	0	1	1	0	0	0	1	0	62
C	0	0	1	0	0	0	1	1	23
1	0	1	0	1	0	0	0	1	51
2	0	1	0	1	0	0	1	0	52
3	0	0	0	1	0	0	1	1	13
?	0	0	0	1	1	1	1	1	1F
LRC	0	0	1	0	1	0	1	0	2A

HEX

	B3	B2	B1	B0
0	0	0	0	0
1	0	0	0	1
2	0	0	1	0
3	0	0	1	1
4	0	1	0	0
5	0	1	0	1
6	0	1	1	0
7	0	1	1	1
8	1	0	0	0
9	1	0	0	1
A	1	0	1	0
B	1	0	1	1
C	1	1	0	0
D	1	1	0	1
E	1	1	1	0
F	1	1	1	1

Transfer track 2 (track 3) data to HEX under 05 bits:

	B0	B1	B2	B3	P
;	1	1	0	1	0
1	1	0	0	0	0
2	0	1	0	0	0
3	1	1	0	0	1

4	0	0	1	0	0
5	1	0	1	0	1
?	1	1	1	1	1
LRC	1	0	1	0	1

	Add 0	Add 0	Add 0	P	B3	B2	B1	B0	HEX
;	0	0	0	0	1	0	1	1	0B
1	0	0	0	0	0	0	0	1	01
2	0	0	0	0	0	0	1	0	02
3	0	0	0	1	0	0	1	1	13
4	0	0	0	0	0	1	0	0	04
5	0	0	0	1	0	1	0	1	15
?	0	0	0	1	1	1	1	1	1F
LRC	0	0	0	1	0	1	0	1	15

06, 05, 06 BITS

Set TK1, TK2 & TK3 as 06, 05, 06

First of all, set BPI command:

1b, 6F, 06, 05, 06

Present the information to the card encoder, as follows:

Start Field	1B6E1B73
Track1 header	1B01
Length	09
Track1 data	052122231112131F2A
Track2 header	1B02
Length	08
Track2 data	0B01021304151F15
Track3 header	1B03
Length	08
Track3 data	0101020304051F1F
Ending Field	3F1C

Transfer track1 data to HEX under 06 bits:

	B0	B1	B2	B3	B4	B5
%	1	0	1	0	0	0
A	1	0	0	0	0	1
B	0	1	0	0	0	1
C	1	1	0	0	0	1
1	1	0	0	0	1	0
2	0	1	0	0	1	0

3	1	1	0	0	1	0
?	1	1	1	1	1	0
LRC	0	1	0	1	0	1

	Add 0	Add 0	B5	B4	B3	B2	B1	B0	HEX
%	0	0	0	0	0	1	0	1	05
A	0	0	1	0	0	0	0	1	21
B	0	0	1	0	0	0	1	0	22
C	0	0	1	0	0	0	1	1	23
1	0	0	0	1	0	0	0	1	11
2	0	0	0	1	0	0	1	0	12
3	0	0	0	1	0	0	1	1	13
?	0	0	0	1	1	1	1	1	1F
LRC	0	0	1	0	1	0	1	0	2A

Transfer track 2 data to HEX under 05 bits:

	B0	B1	B2	B3	P
;	1	1	0	1	0
1	1	0	0	0	0
2	0	1	0	0	0
3	1	1	0	0	1
4	0	0	1	0	0
5	1	0	1	0	1
?	1	1	1	1	1
LRC	1	0	1	0	1

	Add 0	Add 0	Add 0	P	B3	B2	B1	B0	HEX
;	0	0	0	0	1	0	1	1	0B
1	0	0	0	0	0	0	0	1	01
2	0	0	0	0	0	0	1	0	02
3	0	0	0	1	0	0	1	1	13
4	0	0	0	0	0	1	0	0	04
5	0	0	0	1	0	1	0	1	15
?	0	0	0	1	1	1	1	1	1F
LRC	0	0	0	1	0	1	0	1	15

Transfer track 3 data to HEX under 06 bits:

	B0	B1	B2	B3	B4	B5

!	1	0	0	0	0	0
1	1	0	0	0	0	0
2	0	1	0	0	0	0
3	1	1	0	0	0	0
4	0	0	1	0	0	0
5	1	0	1	0	0	0
?	1	1	1	1	1	0
LRC	1	1	1	1	1	0

	Add 0	Add 0	B5	B4	B3	B2	B1	B0	HEX
!	0	0	0	0	0	0	0	1	01
1	0	0	0	0	0	0	0	1	01
2	0	0	0	0	0	0	1	0	02
3	0	0	0	0	0	0	1	1	03
4	0	0	0	0	0	1	0	0	04
5	0	0	0	0	0	1	0	1	05
?	0	0	0	1	1	1	1	1	1F
LRC	0	0	0	1	1	1	1	1	1F